



260.2720 | 3/4" Horizontal Thermostatic Valve & Trim With Integrated Volume Control - For Tub or Shower Applications

SPECIFICATIONS:

- Solid Brass construction
- Single output
- Bottom knob controls temperature
- Top knob controls volume
- Use in tub filler or shower applications
- Thermostatic Valve Flow Rate - 8.0 GPM @ 60 PSI

STANDARDS:

- ASME A112.18.1 / CSA B125.1

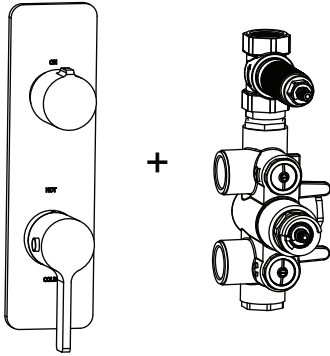

Valve [TVH.2693] + Trim [260.4000VT**]

Legislation Compliance



ZeroDrip Technology



See Spec Sheet For TVH.2693 For Detailed Information On Valve.

Technical Diagram

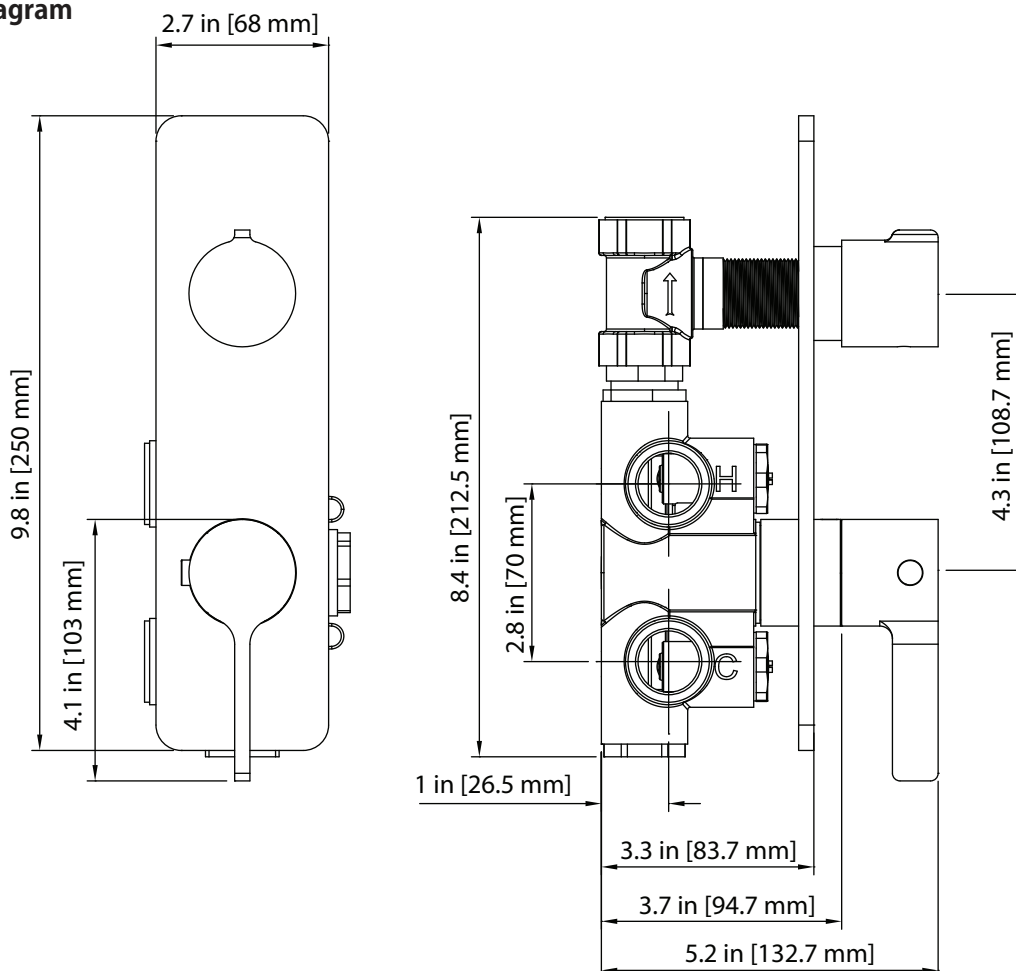

Critical Dimensions in Inches [mm]